

Triumph Play Systems

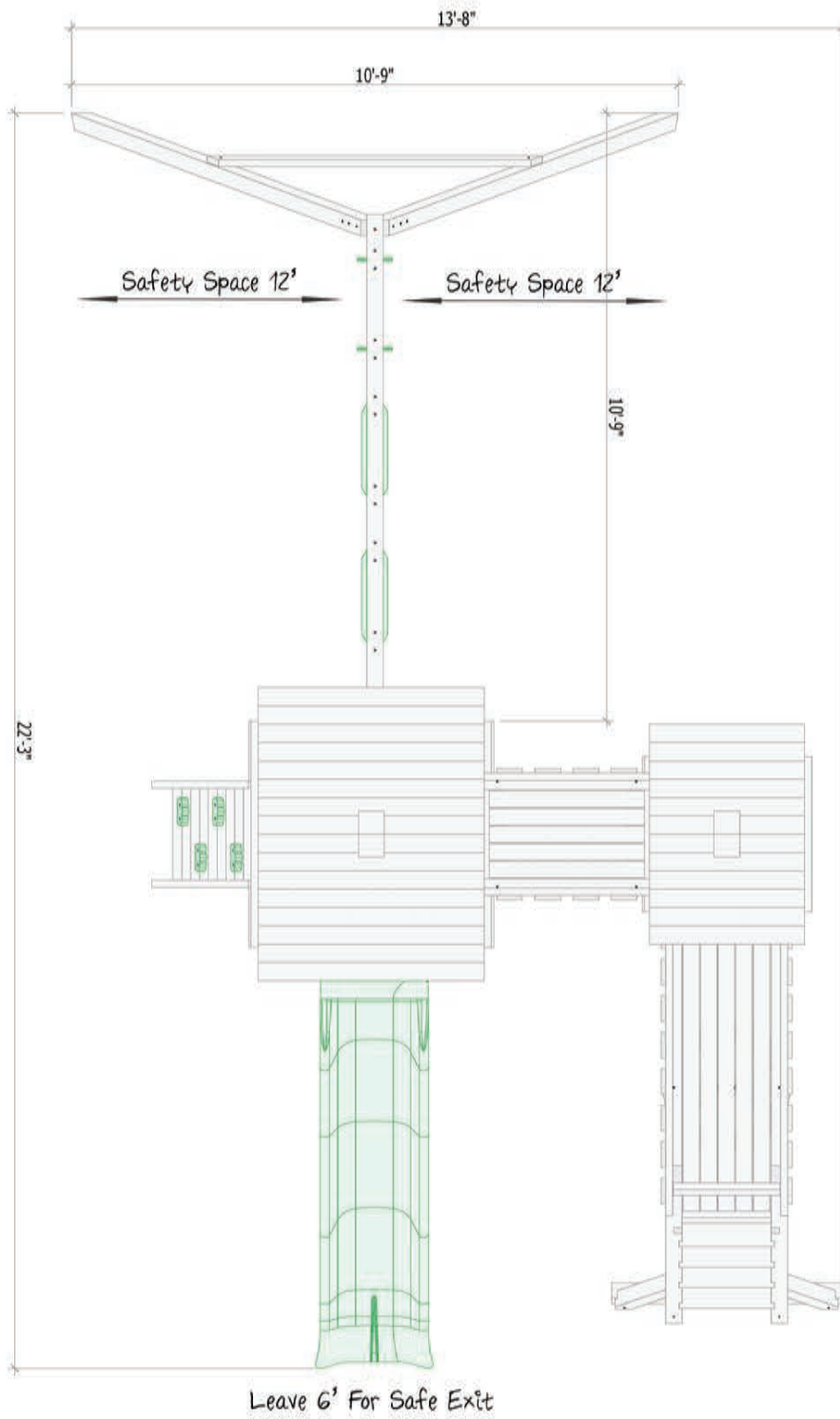

Festival Nine Assembly Directions



Festival Nine

Triumph Play Systems
 15 Maple Ave.
 Ashburnham, MA



Step One: Side Wall Assembly

1.1 With a hammer, insert T-Nuts into Corner Post - L and Corner Post - R as shown in Figure 1.0. Note direction of the Lap Joints at the top of the posts.

1.2 Fasten Top Support 48" to top and bottom of Corner post with 5/16 x 4-1/2 Hex Bolts with 5/16 washer as shown in Figure 1.1. Tighten until T-Nuts are flush with surface.

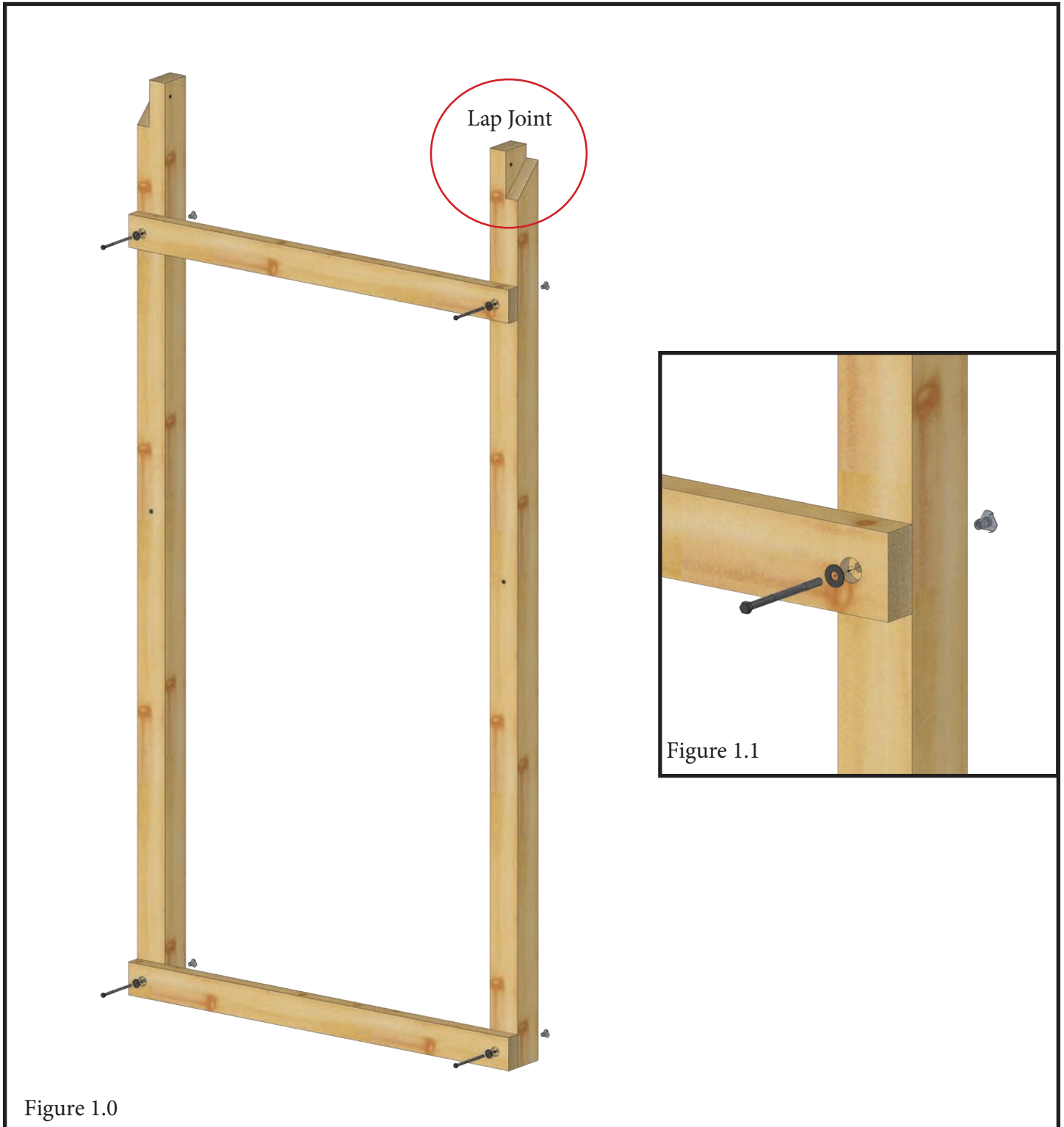

Step Two: Swing Beam Side Wall Assembly

2.1 With a hammer, insert T-Nuts into Corner Post - L and Corner Post - R as shown in Figure 2.0. Note direction of the Lap Joints at the top of the posts.

2.2 Fasten Top Support 48" to bottom of Corner Post with 5/16 x 4-1/2 Hex Bolts with 5/16 washer. Tighten until T-Nuts are flush with surface.

2.3 Fasten Swing Beam Support to Corner Post with 5/16 x 6 Hex Bolts with 5/16 washer. Make sure the Countersink hole in center is facing down.

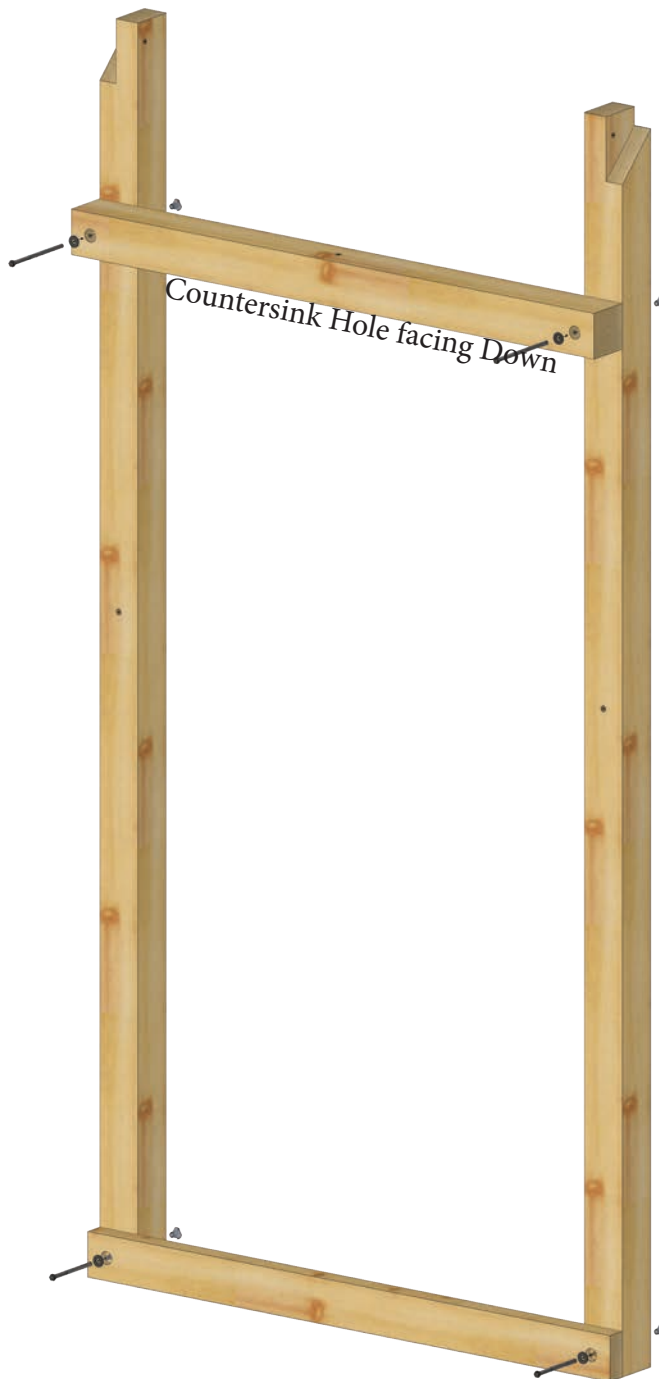

Figure 2.0

Step Three: Deck Supports

3.1 With a hammer, insert T-Nuts into the outside of Corner Post - L and Corner Post - R as shown in Figure 3.0.

3.2 Fasten Deck Support 48" to Corner Post with 5/16 x 6 Hex Bolts with 5/16 washer.



Figure 3.0

Step Four:

4.1 Pre-drill and Fasten Deck Boards 41" to Deck Supports with #8x2-1/2 Screws (4 each) as shown in Figure 4.0.



Figure 4.0

Step Five:

5.1 Fasten Top Panel Offset 48" (3) to Corner Post with 5/16 x 3 Lag Bolt with 5/16 washer as shown in Figure 5.0. Drive lags until washer starts to "sink" into wood.

5.2 Fasten Top Panel Offset 12" (2) to Corner Post with 5/16 x 3 Lag Bolt with 5/16 washer as shown in Figure 5.0.

5.3 Place the tower in desired location. Check for square, level under the frame and check the posts for plumb.



Figure 5.0

Step Six: Angle Braces

6.1 Fasten Slim Sams (4) to Corner Posts and Deck Supports with 5/16 x 3 Lag Bolts with 5/16 washer as shown in Figure 6.0.

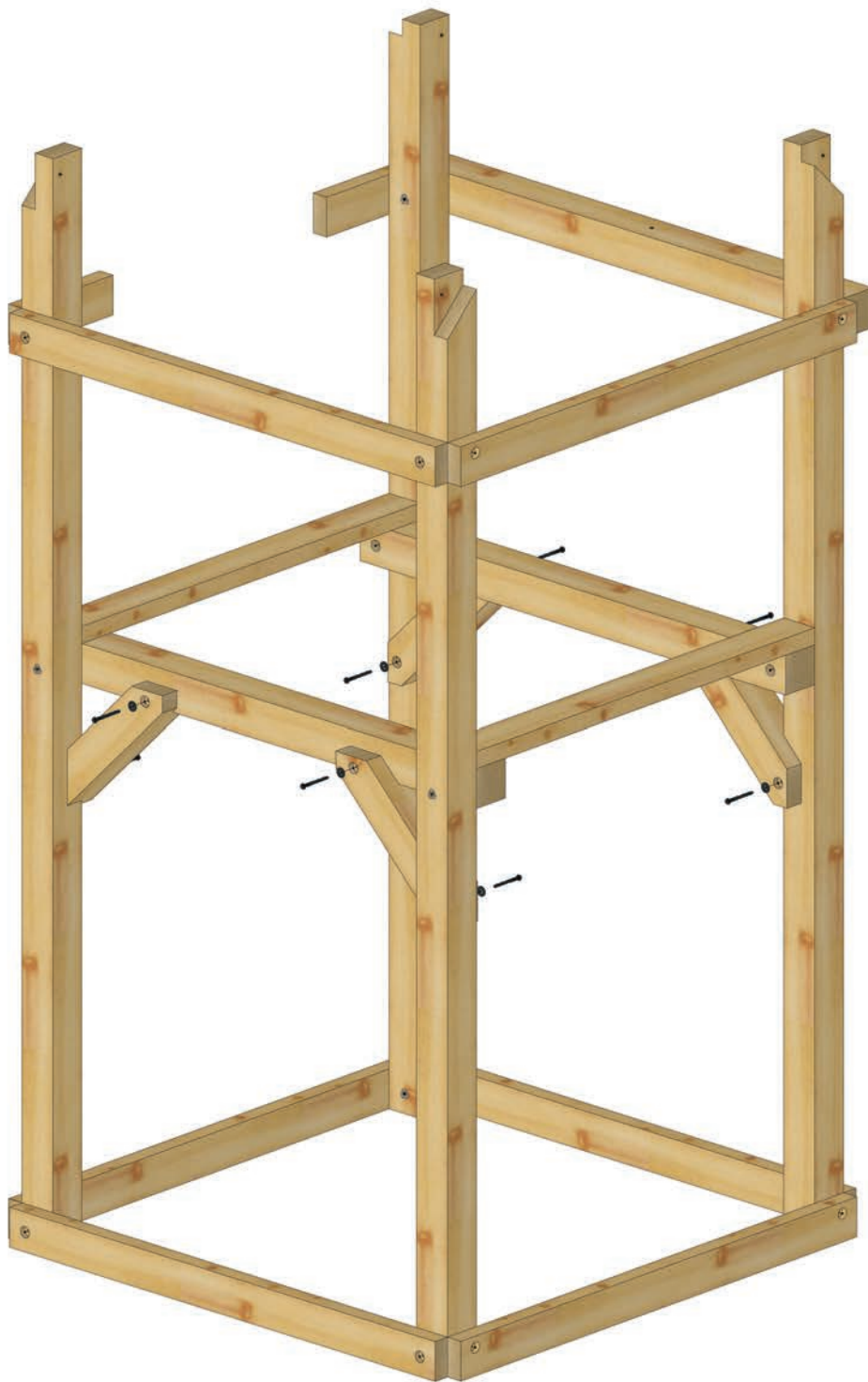

Figure 6.0

Step Seven: Lower Walls

7.1 Measure up from the ground 22-1/2 inches and mark the corner posts.

7.2 Fasten Top Panel Offset 48" (3) to Corner Post with 5/16 x 3 Lag Bolts with 5/16 washer as shown in Figure 7.0. Be sure to flip the orientation as you go to avoid the lags colliding in each corner post.

7.3 Fasten Top Support 12" to Corner Post with 5/16 x 3 Lag Bolts with 5/16 washer as shown in Figure 7.0.

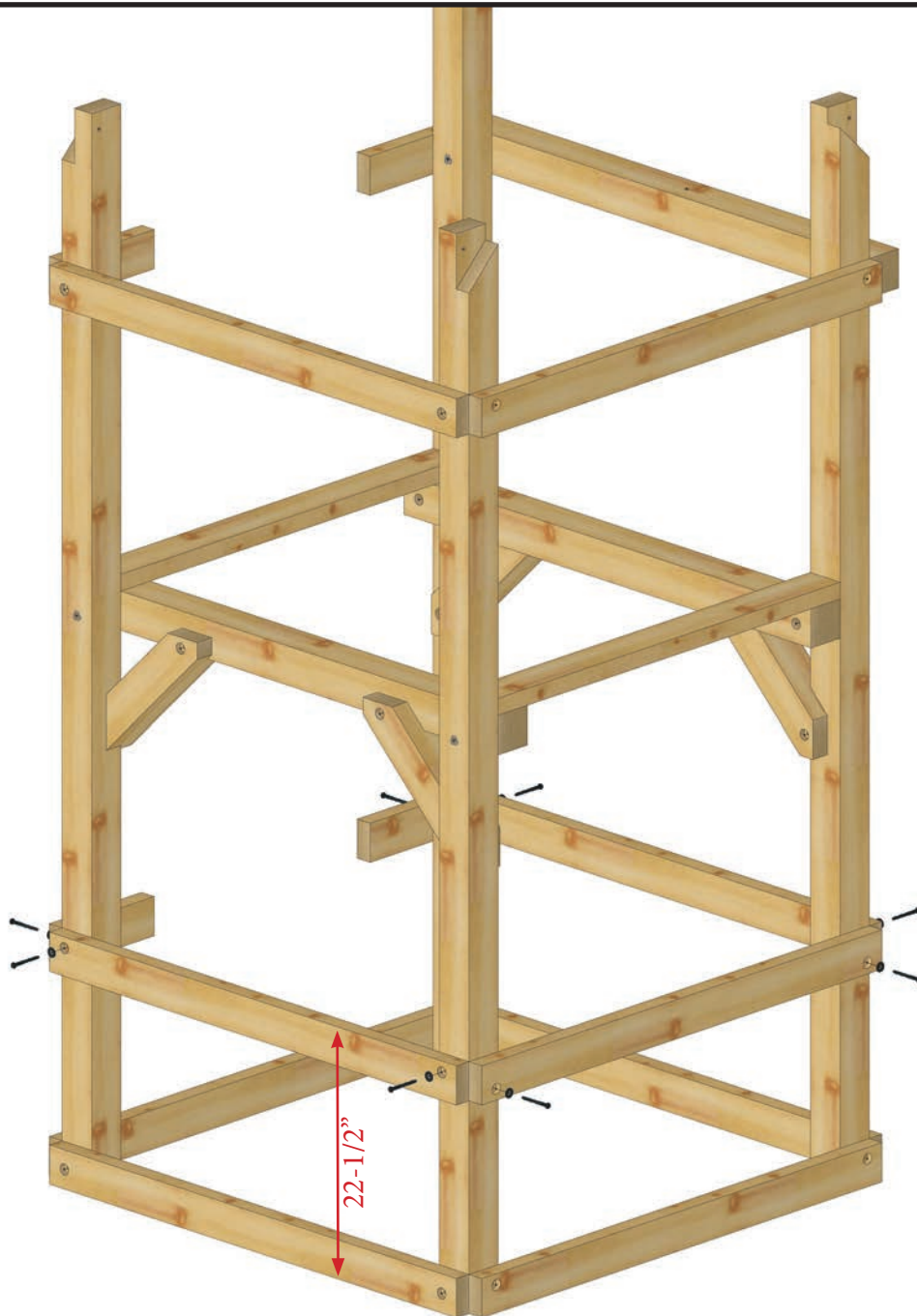

Figure 7.0

Step Eight: Lower Wall Slats

8.1 Pre-drill and fasten Slat 22.5" to Top Panels with #8x2 screws as shown in Figure 8.0. (Spacing between slats is about 2-1/4")

8.2 Pre-drill and fasten Counter 48" to Top Panels with #8x2 screws as shown in Figure 8.1.

8.3 Pre-drill and fasten Counter 12" to Top Panel 12" with #8x2 screws as shown in Figure 8.1.

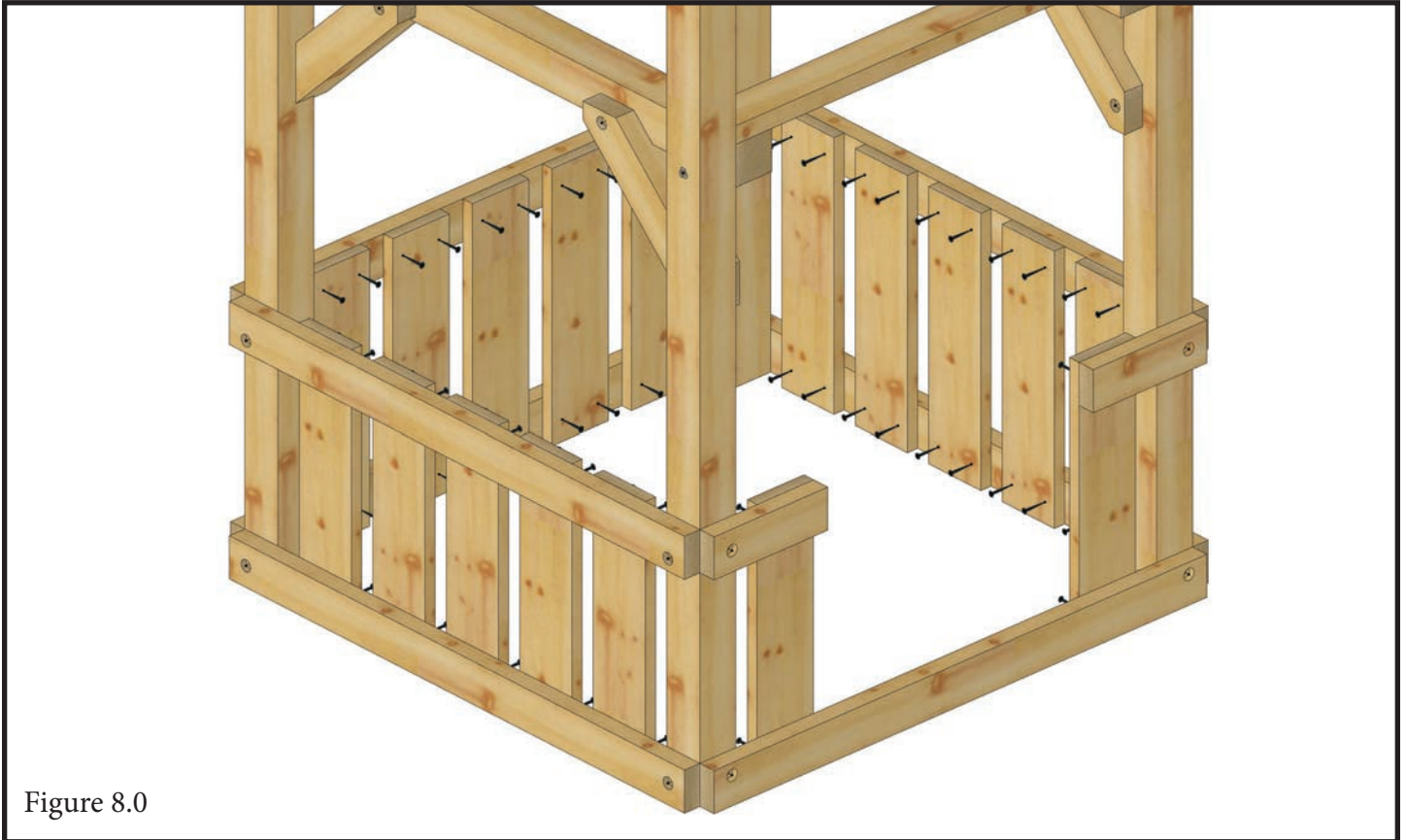

Figure 8.0

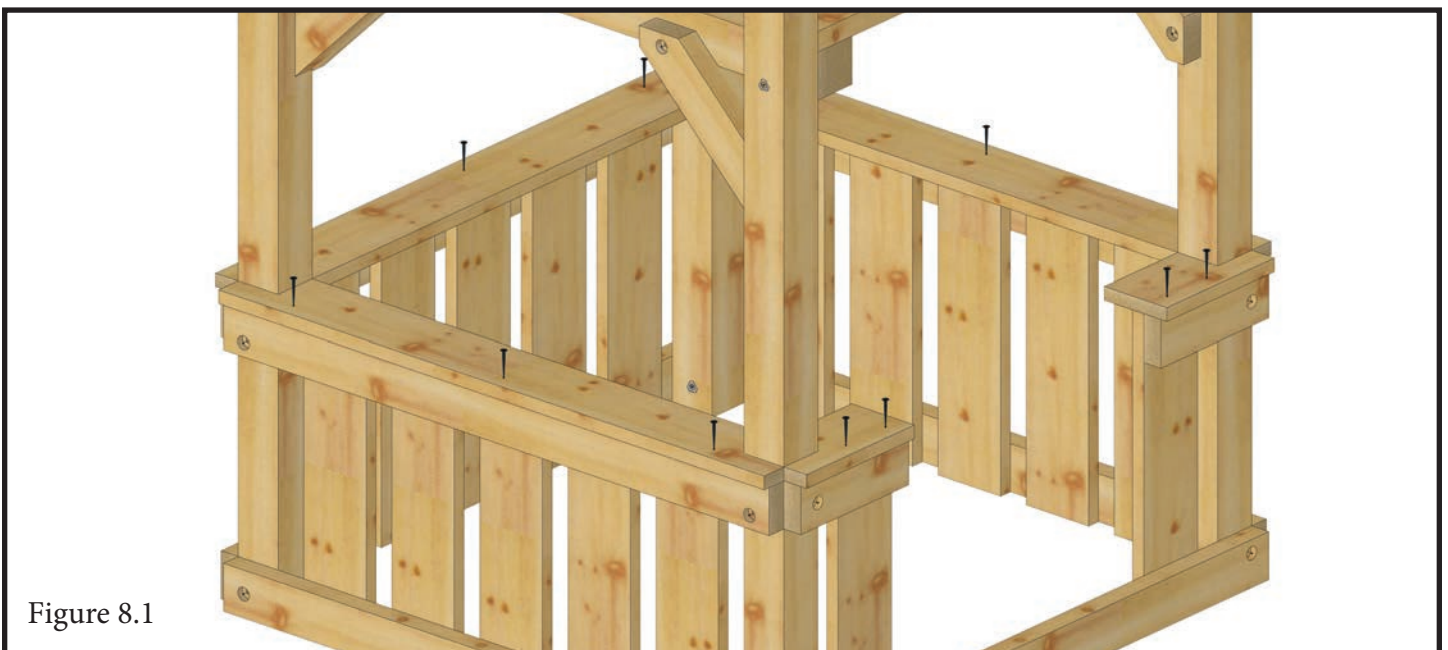

Figure 8.1

Step Nine: Deck Boards

9.1 Pre-drill and evenly space out deck board 48".

9.2 Fasten Deck Board 48" to Deck Supports with #8x2-1/2" screws (4 each) as shown in Figure 9.1.

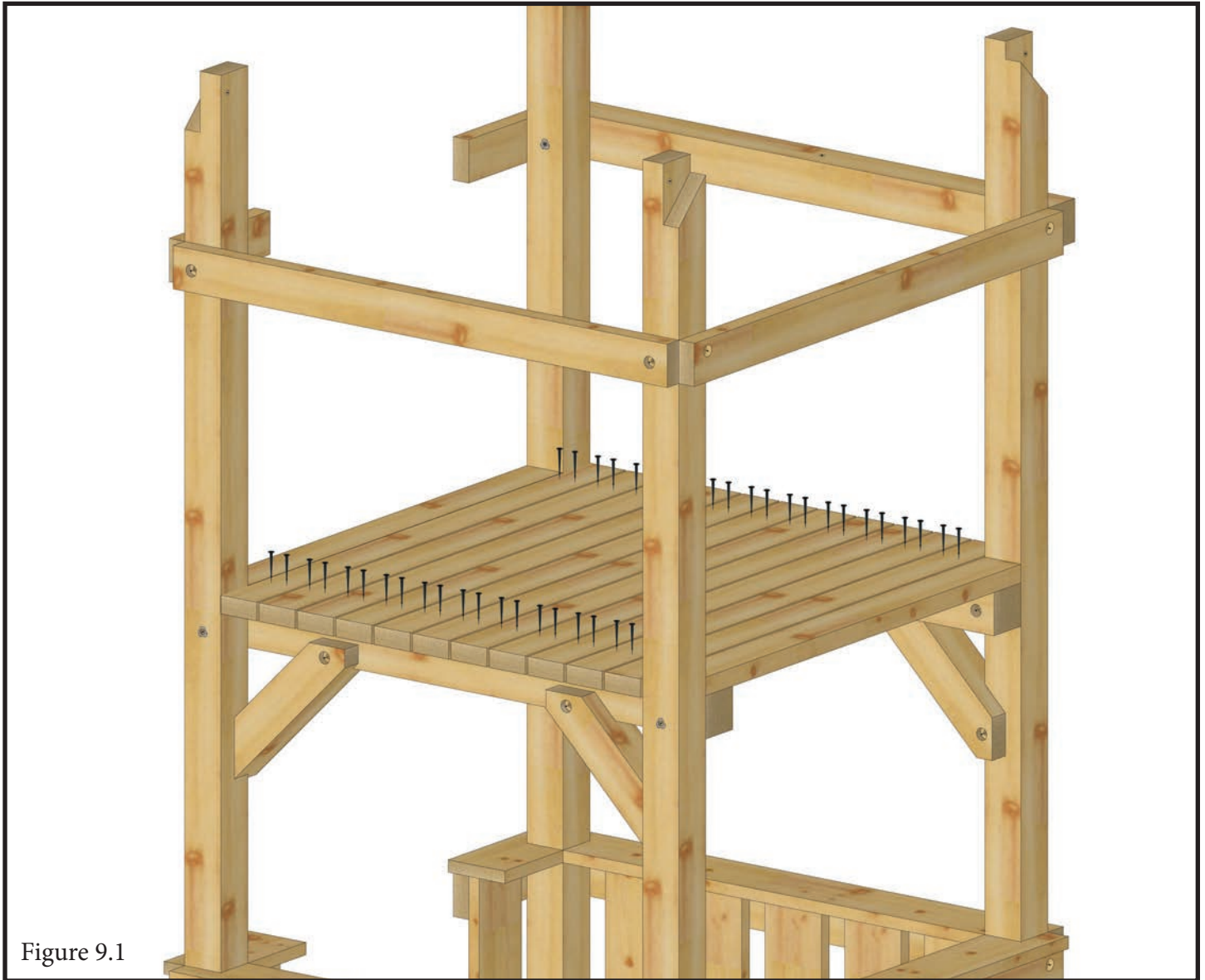

Figure 9.0 Shows how to use the screws for spreading out deck boards with even spacing.

Step Ten: Rock Wall Pre-Assembly

10.1 Measure up from the bottom (back) of Rock Wall Runners 2-3/8" and Mark.

10.2 Pre-drill and fasten Slat 22.5" (9) to Rock Wall Runners with 2" Screws.

Figure 10.1

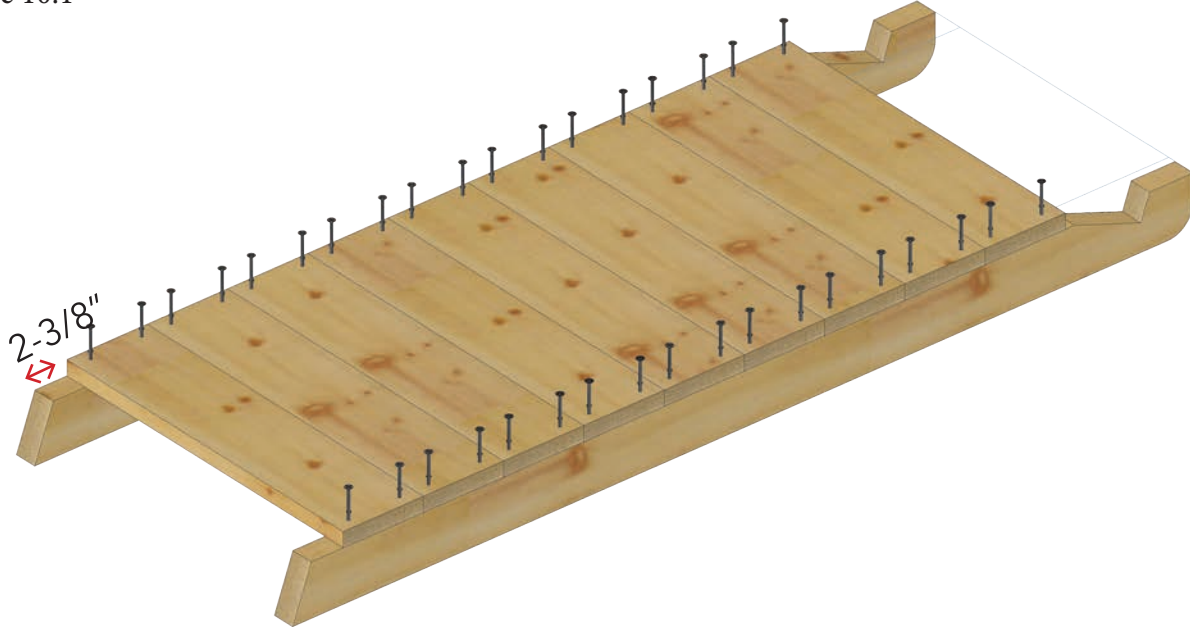

Figure 10.2



10.3 Place plastic Rocks in desired positions.

10.4 With a 3/8 drill bit, drill holes through the rock and the slat.

10.5 Hammer in T-Nuts to back of the wall.

10.6 Fasten plastic rocks with 5/16" x 1-1/2" hex bolts with 5/16" washers.

Step Eleven: Bridge Pre-Assembly

11.1 Fasten GW Deck Supports (2) to Bridge Supports 40" with 5/16 x 4-1/2 Hex Bolts and 5/16 washer into T-Nut as shown in Figure 11.3.

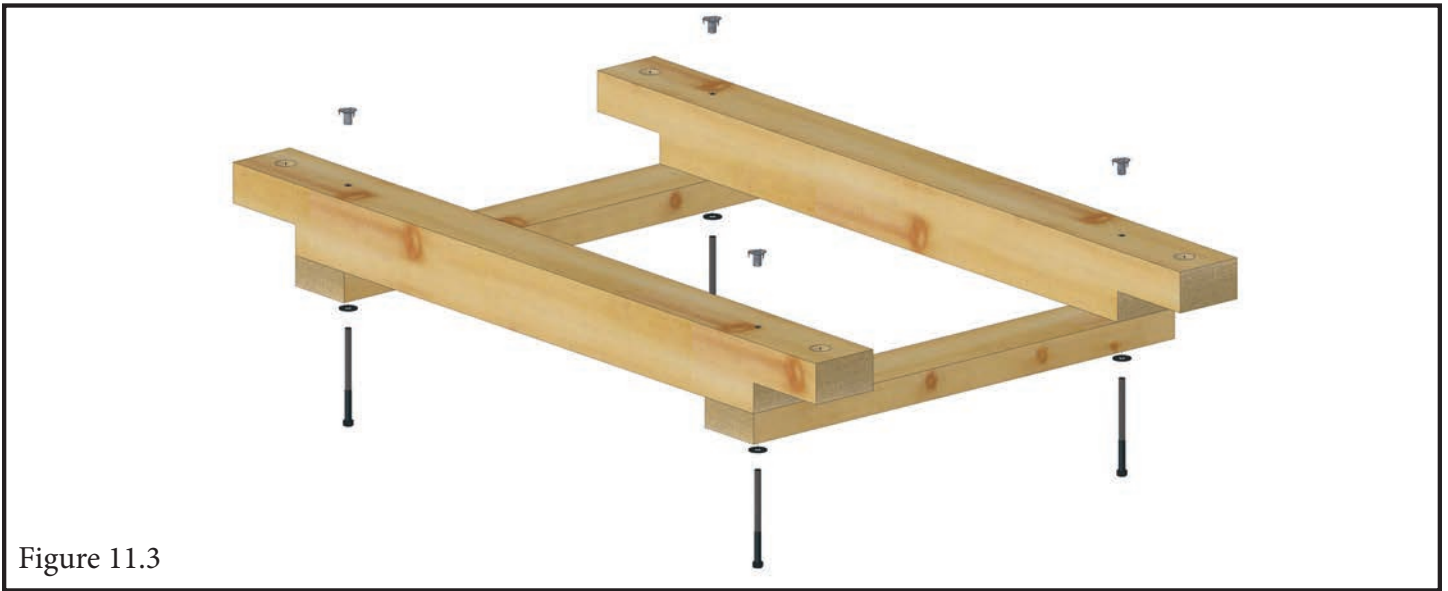
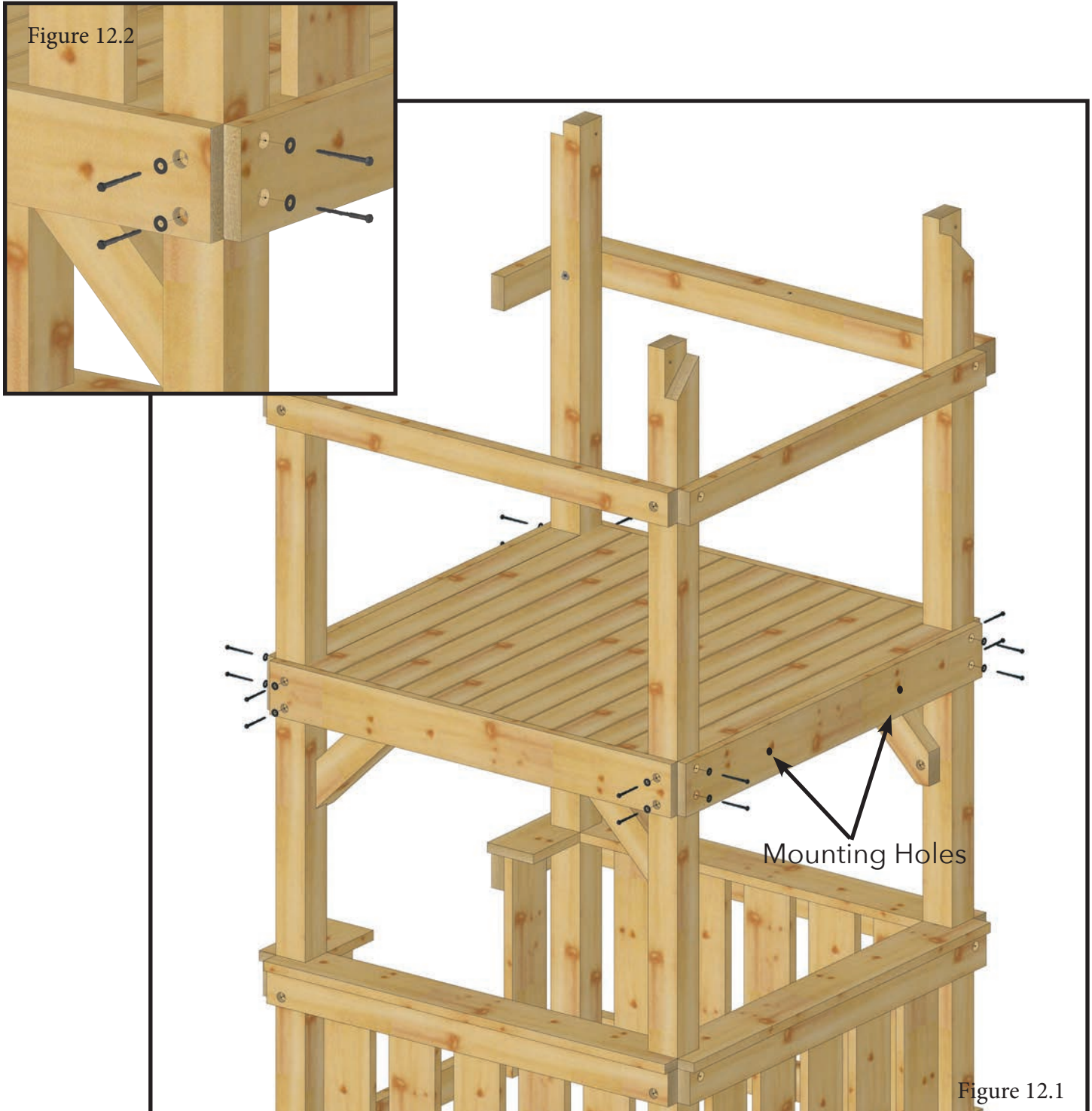

Figure 11.3

Step Twelve: Fascia Boards

12.1 Fasten Fascia Mount 48" (1) to Corner Post with 1/4 x 2-1/2 Lag Bolts with 1/4 washer as shown in Figure 12.1

12.2 Fasten Fascia 48" (3) to Corner Post with 1/4 x 2-1/2 Lag Bolts with 1/4 washer as shown in Figure 12.1. Mind the offset pattern as shown in Figure 12.2.



Step Thirteen: Attaching the Rock Wall

13.1 Fasten Rock Wall Assembly to Fascia Gable Side with (2) 5/16 x 3 Lag Bolts with 5/16 washer as shown in Figure 13.2.

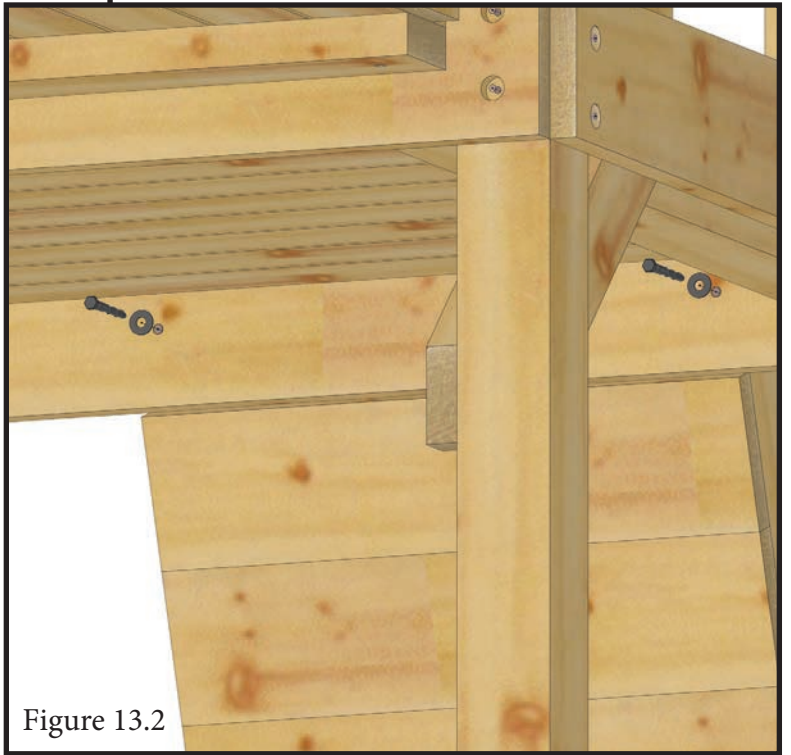

Figure 13.2

Figure 13.2

Step Fourteen: Tower Side Wall Assembly

14.1 With a hammer, insert T-Nuts into Corner Post - L and Corner Post - R as shown in Figure 14.1 and 14.2. Note direction of the Lap Joints at the top of the posts.

14.2 Fasten Top Support 33" to top and bottom of Corner post with 5/16 x 4-1/2 Hex Bolts with 5/16 washer as shown in Figure 14.1. Tighten until T-Nuts are flush with surface.

14.3 Fasten Deck Support 33" to Corner Post with 5/16 x 6 Hex Bolts with 5/16 washer.

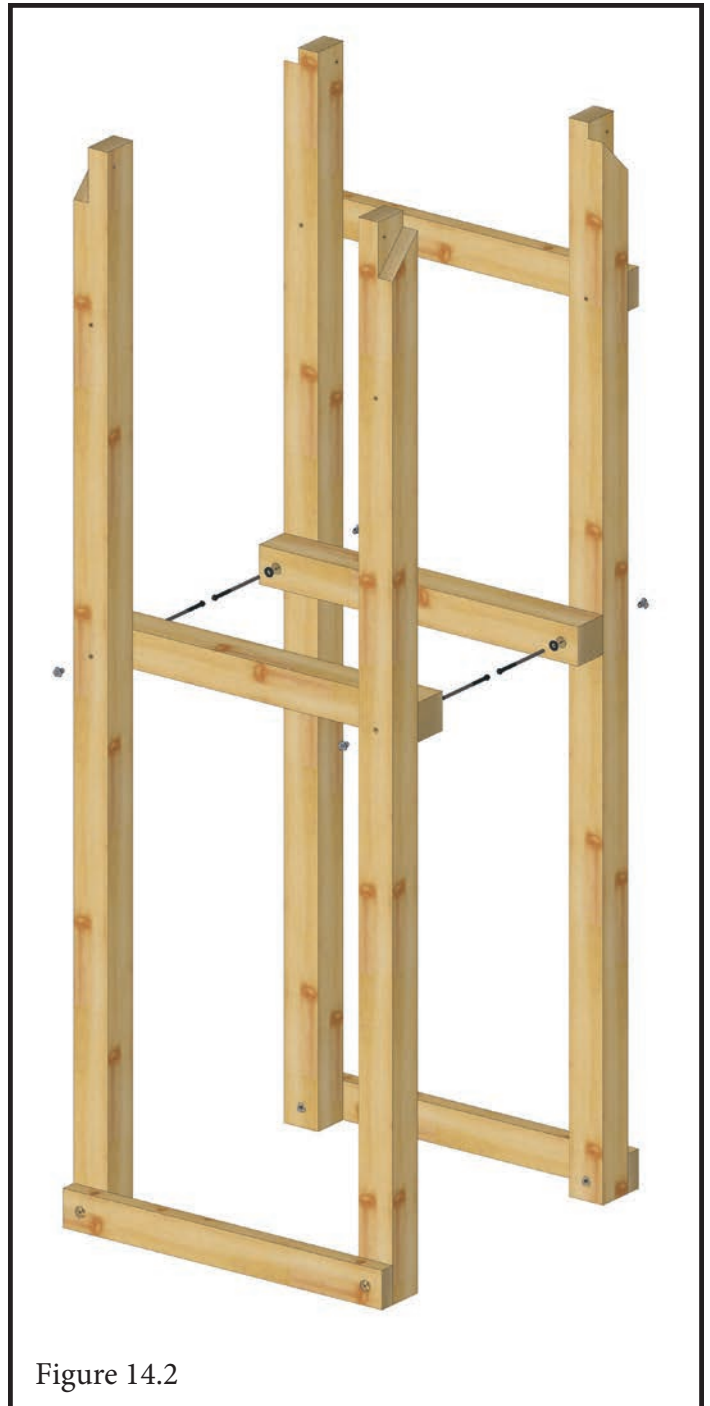

Step Fifteen: Tower Assembly

15.1 Pre-drill and Fasten Deck Boards 26" (2) to Deck Supports with #8x2-1/2 Screws (4 each) as shown in Figure 15.1.

15.2 Fasten Top Panel Offset 33" (3) to Corner Post with 5/16 x 3 Lag Bolts with 5/16 washer. Drive lags until washer starts to "sink" into wood.

15.3 Place the towers in desired location. Check for square, level under the frame and check the posts for plumb.

15.4 Fasten Slim Sams (4) to Corner Posts and Deck Supports with 5/16 x 3 Lag Bolts with 5/16 washer as shown in Figure 15.2.

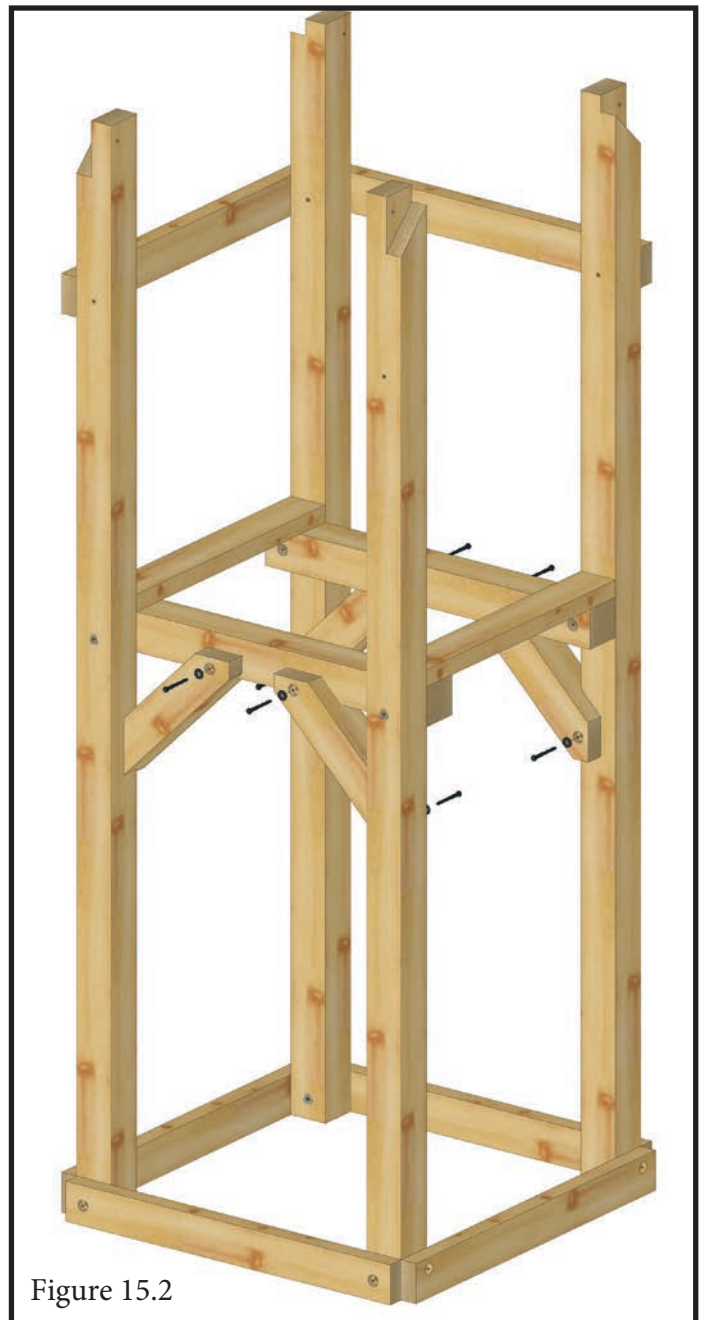

Step Sixteen: Deck Boards & Fascia Boards

16.1 Pre-drill and evenly space out Deck Boards 33" as shown in Figure 16.1.

16.2 Fasten Fascia 33" (4) to Corner Post with 1/4 x 2-1/2 Lag Bolts with 1/4 washer as shown in Figure 16.2. Mind the offset pattern.

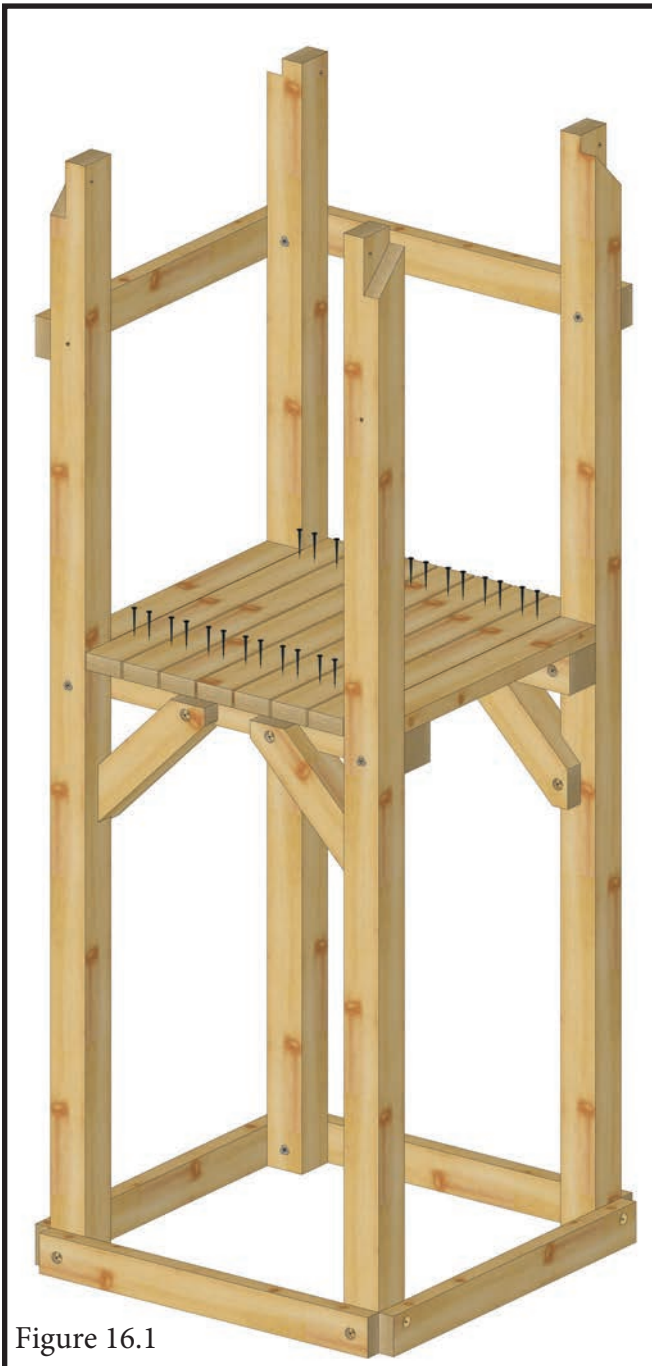

Figure 16.1

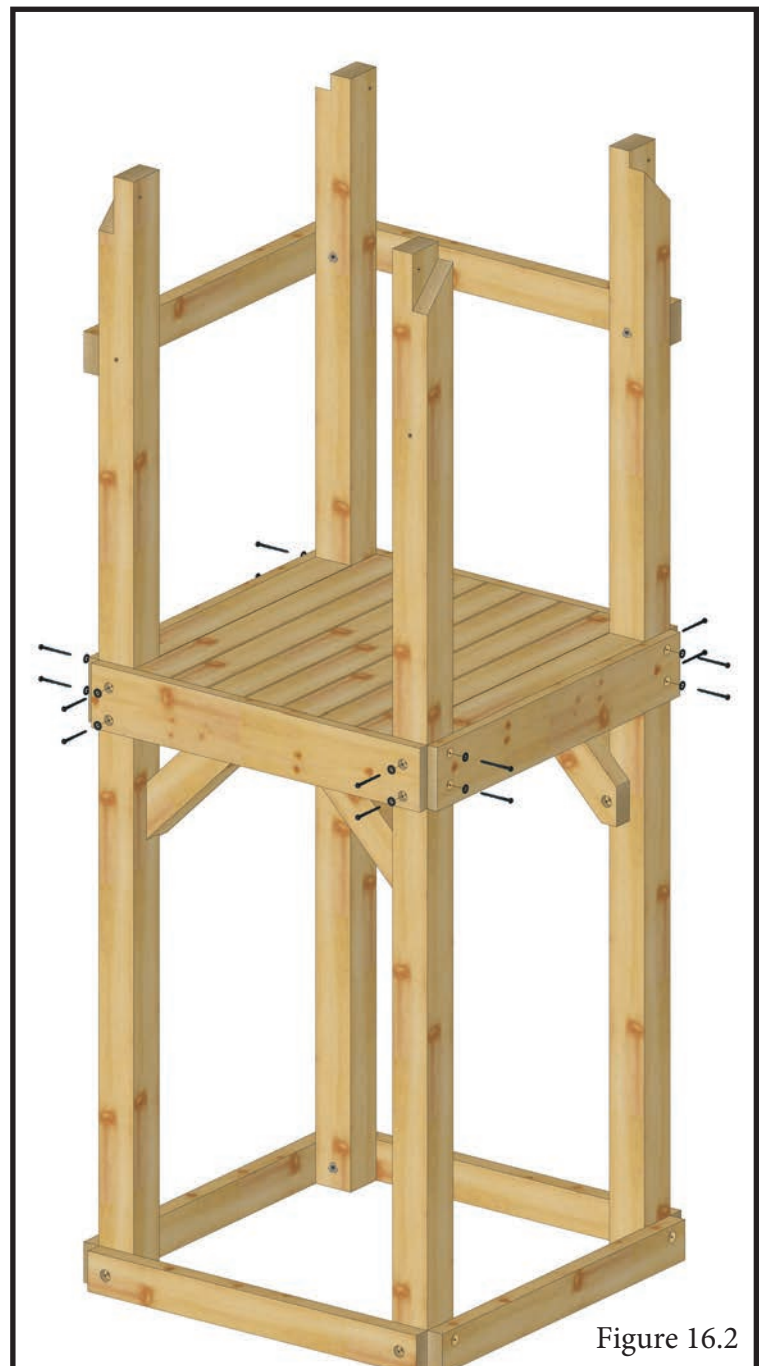

Figure 16.2

Step Seventeen: Bridge

17.1 Fasten Bridge Assembly down into deck of both towers with 5/16 x 3 Lag Bolts with 5/16 washer.

17.2 Pre-drill and fasten Bridge Deck Boards 33" down with 2-1/2" Screws as shown in Figure 17.1.

17.3 Fasten Bridge Rails 38.5" to the Tower Posts with 5/16 x 3 Lag Bolts with 5/16 washer.

17.4 Pre-drill and Fasten Bridge Rails 38.5" to Top Support Offset 12" with #8x2-1/2" screws as shown in Figure 17.1.

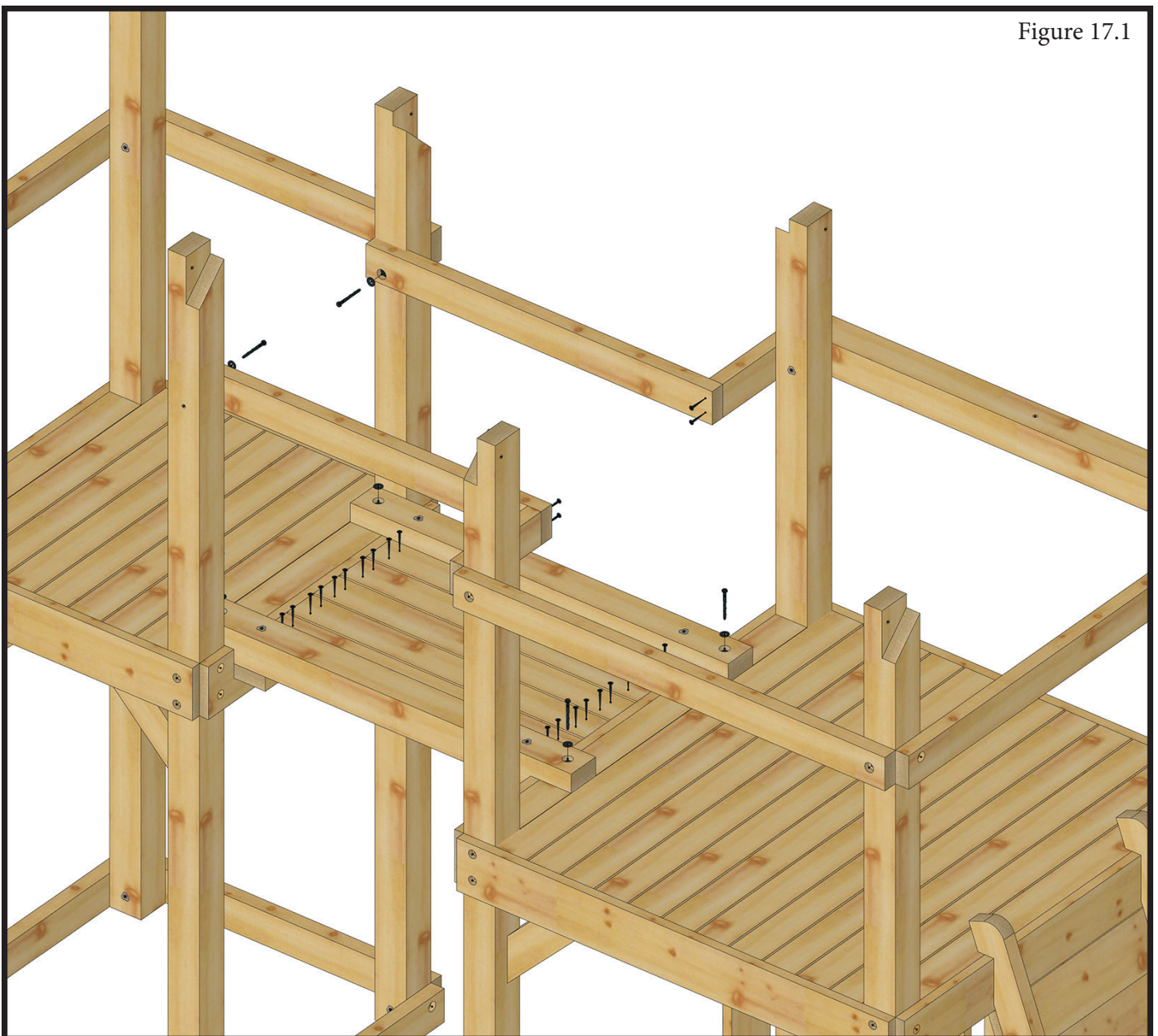

Step Eighteen: Wall Slats

18.1 With roughly 2-1/4" spacing between slats, fasten the Pocket Slat 28" Boards down to the decks with 2" Screws as shown in Figure 18.2

18.2 Pre-drill and Fasten the top of the Pocket Slat 28" with 2" Screws as shown in Figure 18.1.

18.3 Pre-drill and fasten Slat 29.5" between bridge deck support and bridge rails.



Step Nineteen: Roof Rafters

19.1 Fasten Roof Rafter-L and Roof Rafter-R to Roof Brace with 5/16" x 2" Hex Bolts with 5/16" washers into t-nuts as shown in Figure 19.1. Repeat for opposite peak side.

19.2 Fasten Roof Rafter SH-L and Roof Rafter SH-R to Roof Brace with 5/16" x 2" Hex Bolts with 5/16" washers into t-nuts as shown in Figure 19.2. Repeat for opposite peak side.

19.3 Add two 2" screws to align each peak.

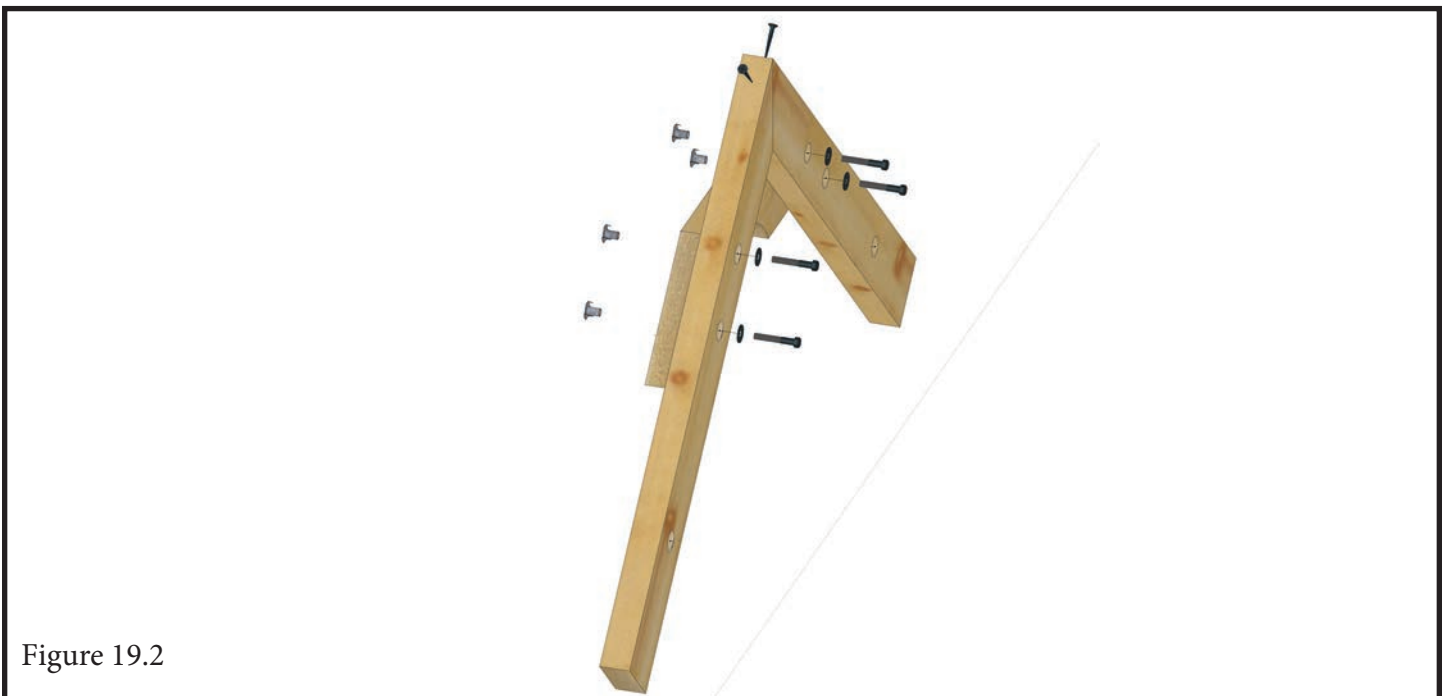
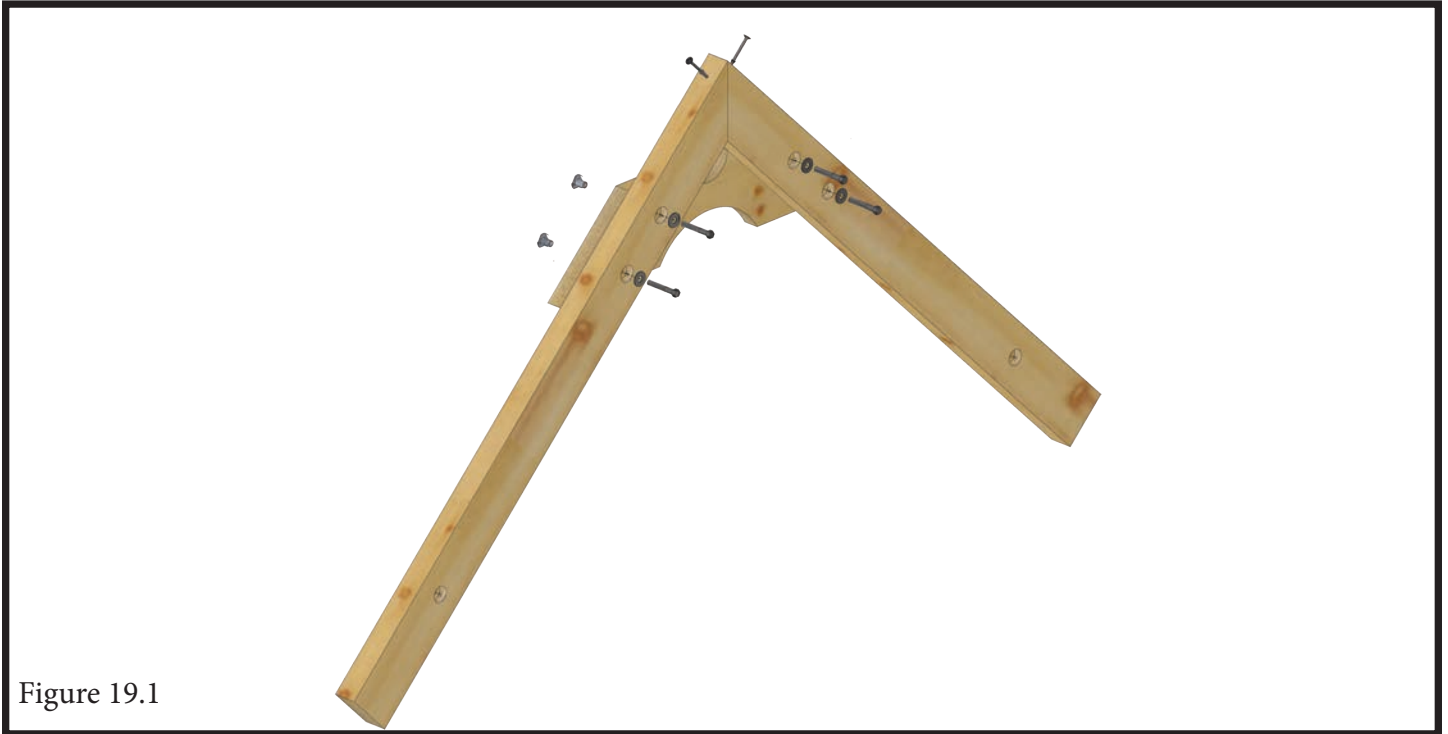

Step Twenty: Roof Rafters

20.1 Fasten Rafter Assemblies to Corner Post with 5/16" x 3" Hex Bolts with 5/16" washer into T-Nuts as shown in Figure 20.1.



Figure 20.1

Step Twenty-One: Wood Roof

21.1 Pre-drill and fasten Roof Peak Boards to Rafter Assembly with 2" Screws as shown.

21.2 Pre-drill and fasten Cupola to Roof Peak Board with 2" Screws as shown (2 per side).

21.3 Pre-drill and fasten Cupola Roof to Cupola with 2" Screws as shown (2 per side).

21.4 Pre-drill and fasten remaining Roof Boards to Rafter Assembly with 2" Screws.

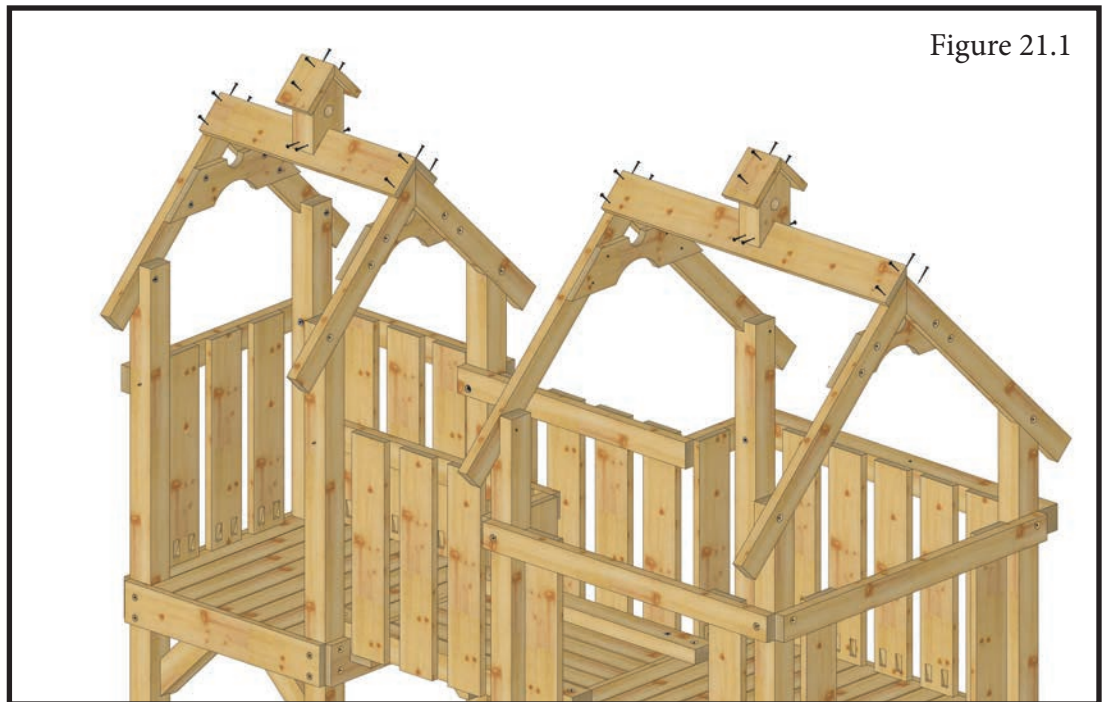

Figure 21.1



Figure 21.2

Step Twenty-Two: Gangway Ladder

22.1 Place Ladder Steps into Dado of GW Ladder Runners as shown in Figure 22.1.

22.2 Pre-drill and fasten Steps with 4" Screws.

22.3 Fasten Bottom Runners to GW Ladder Runners with 5/16 x 6 Hex Bolts and 5/16 washer into T-Nuts as shown in Figure 22.2.

22.4 Fasten Slim Sams (2) between Ladder Runners and Bottom Runners with 5/16 x 3 Lag Bolts with 5/16 washer as shown in Figure 22.2.

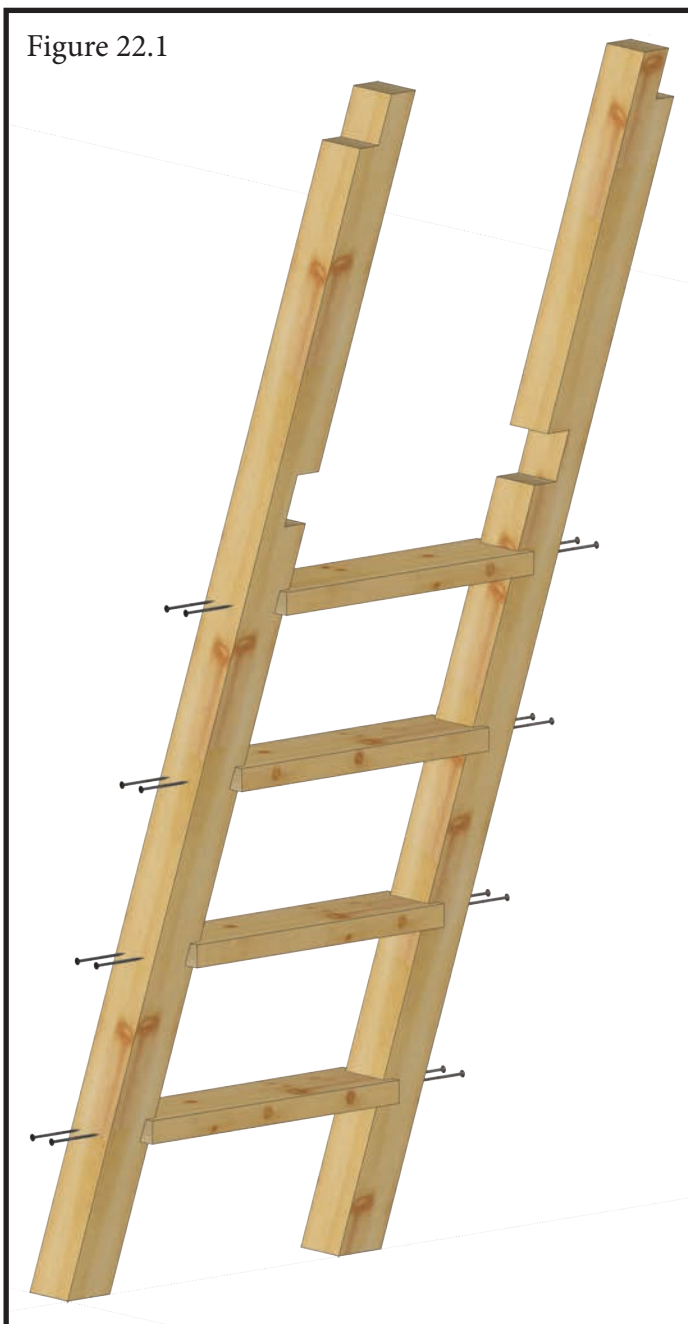

Step Twenty-Three: Gangway

23.1 Fasten Gangway Runners to GW Ladder Runner with 5/16 x 3-1/2 Hex Bolts and 5/16 washer into T-Nuts as shown in Figure 23.1.

23.2 Fasten Gangway Runners down into the play deck with 5/16 x 3 Lag Bolts with 5/16 washer.

23.3 Fasten Gangway Rails Left and Right to the top of the GW Ladder Runners with 5/16 x 3-1/2 Hex Bolts and 5/16 washer into T-Nuts.

23.4 Fasten tower end of Rails to the Corner Post and Gangway Post with 5/16 x 3 Lag Bolts with 5/16 washer.



Figure 23.1

Step Twenty-Four: Gangway (cont.)

24.1 Fasten GW Ladder Top to the top of the GW ladder Runners with 2-1/2" Screws (4) as shown in Figure 24.1.

24.2 Fasten GW Deck Supports (2) to Gangway Runners with 5/16 x 4-1/2 Hex Bolts and 5/16 washer into T-Nut as shown in Figures 24.1 and 24.2.

24.3 Fasten GW Tire Support to Gangway Runners with 5/16 x 4-1/2 Hex Bolts and 5/16 washer into T-Nut as shown in Figure 24.2.

24.4 Fasten Tire Swivel to Center Deck Support with 5/16 x 1-3/4 Hex Bolts and 5/16 washer into T-Nut as shown in Figure 24.2. Snap spring clips

24.5 Fasten Deck Support to back of GW Ladder Runners with 5/16 x 3 Lag Bolts with 5/16 washer as shown Figure 24.2.

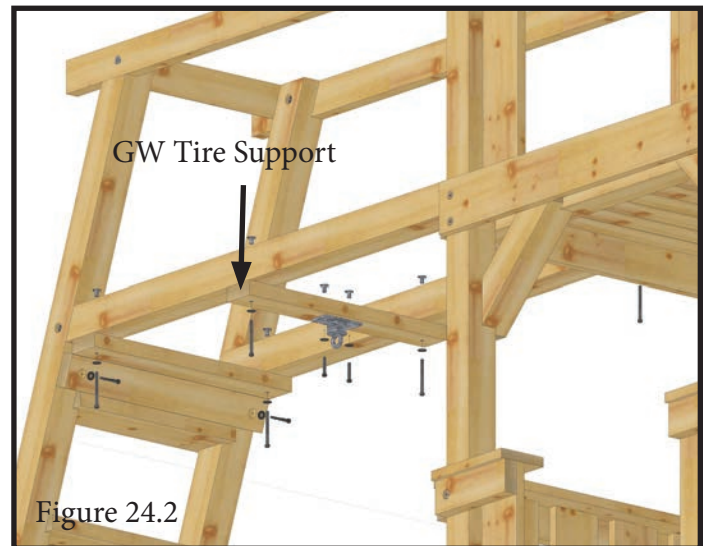

Step Twenty-Five: Gangway (cont.)

25.1 Pre-drill and fasten Gangway Deck Boards Down with 2-1/2" Screws as shown in Figure 25.1.

25.2 Pre-drill and fasten Gangway Slats with 2" Screws as shown in Figure 25.2. Space out evenly, leaving about 2-1/4" between boards.



Step Twenty-Six: A-Frame Pre-Assembly

26.1 Fasten Swing Legs to bracket with 3/8" x 4-1/2" Carriage Bolts with 1/2 Washers. Add 3/8" Washer, Lock Washer, and Nut as shown in Figure 26.1. Do Not Fully Tighten.

26.2 Fasten X-Member between Swing Legs with 5/16"x 4-1/2" Hex Bolts with 5/16" Washer into T-Nuts as shown in Figure 26.2. Do Not Fully Tighten.

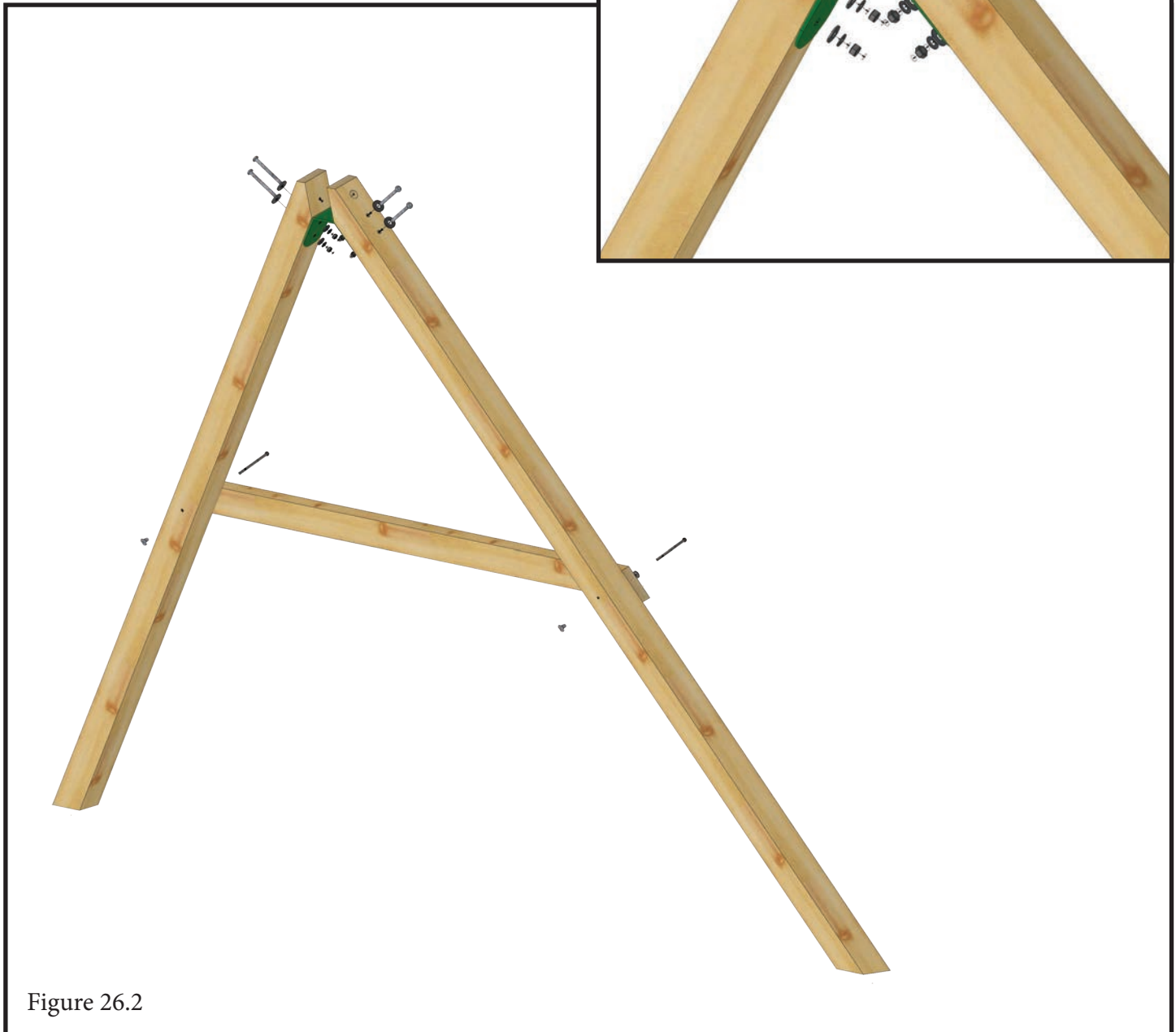
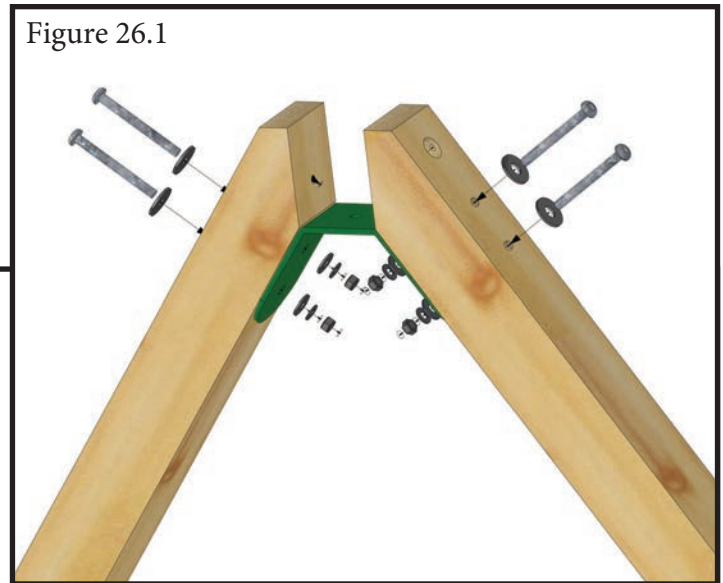
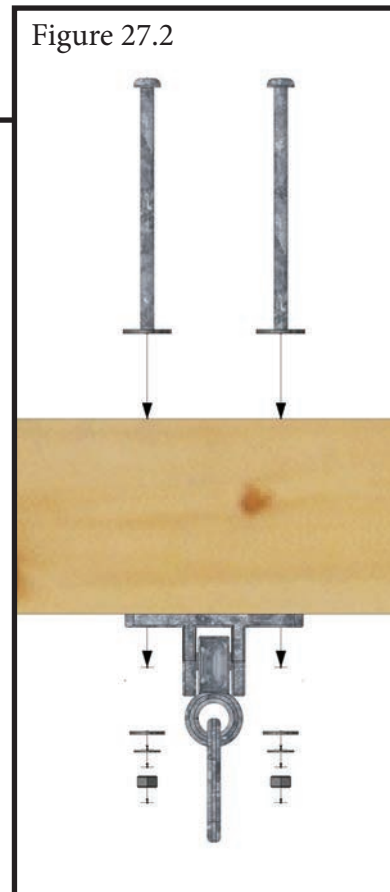
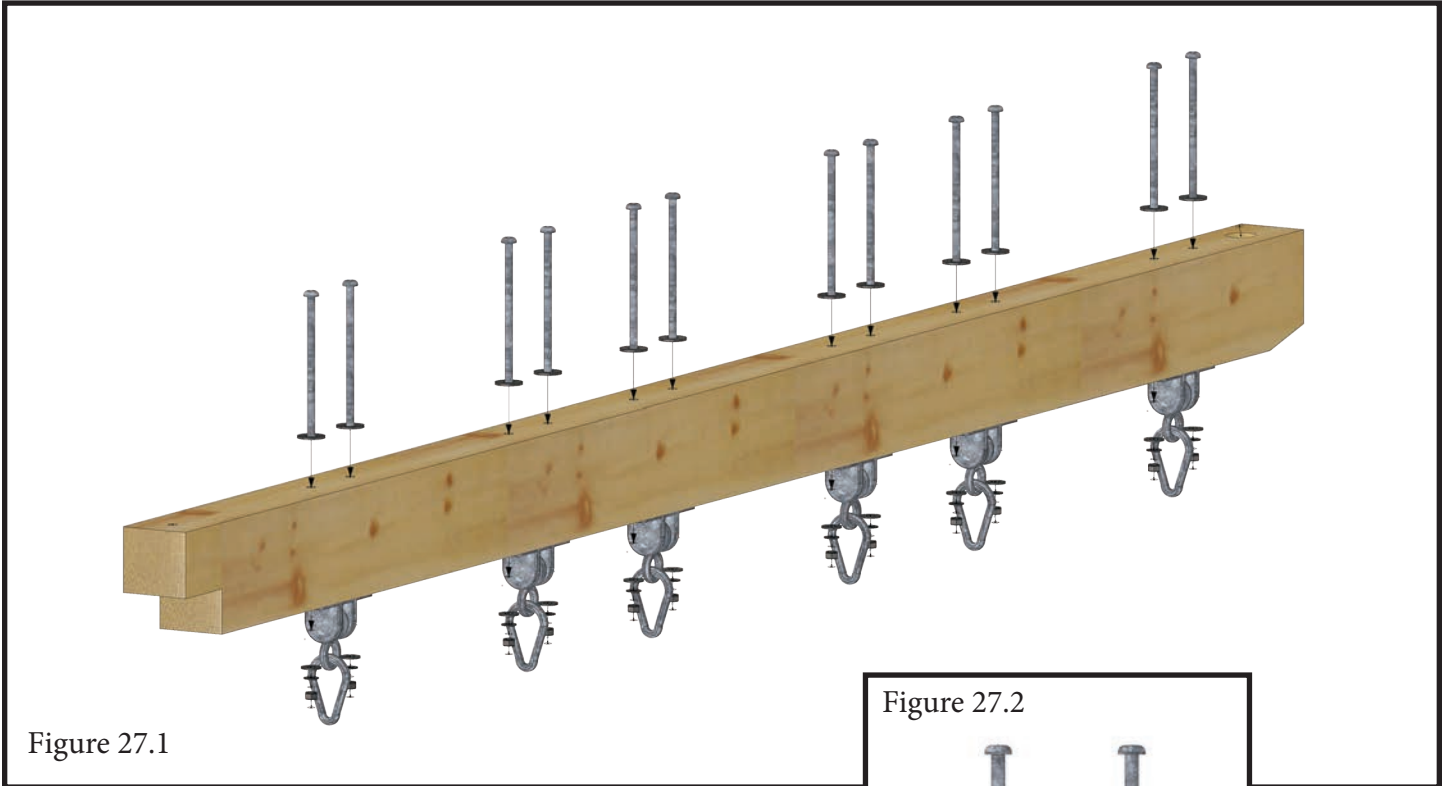

Figure 26.2

Step Twenty-Seven: Swing Beam Pre-Assembly

27.1 Fasten Swing Hangers to Swing Beam with 3/8" x 7" Carriage Bolts with 1/2" Washers. Add 3/8" Washer, Lock Washer, and Nut as shown in Figure 27.2. Tighten until 1/2" washers just start to "sink" into top of beam.

27.2 Snap Spring Clips to Swing Hangers.



Step Twenty-Eight: Swing Arm Assembly

28.1 Fasten Swing Beam Assembly to A-Frame Assembly with 3/8" x 5" Carriage Bolt with 1/2 Washer. Add 3/8" Washer, Lock Washer, and Nut. Tighten.

28.2 Fully tighten nuts from step Twenty-Six.

28.3 Fasten the top of the Swing Legs into the Swing Beam with 5/16" x 3" Lag Bolts with 5/16" washer as shown in Figure 28.1.

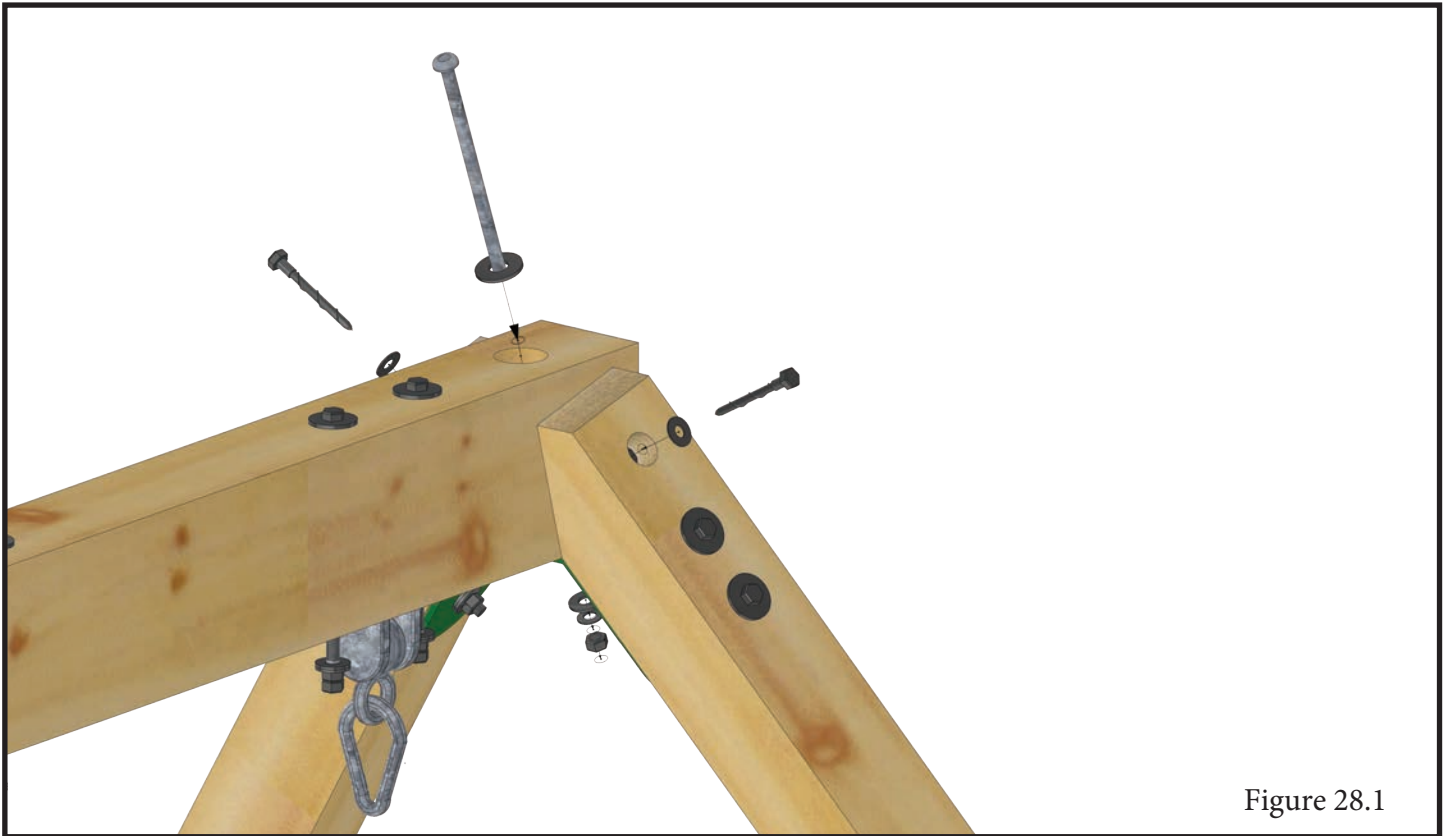

Figure 28.1

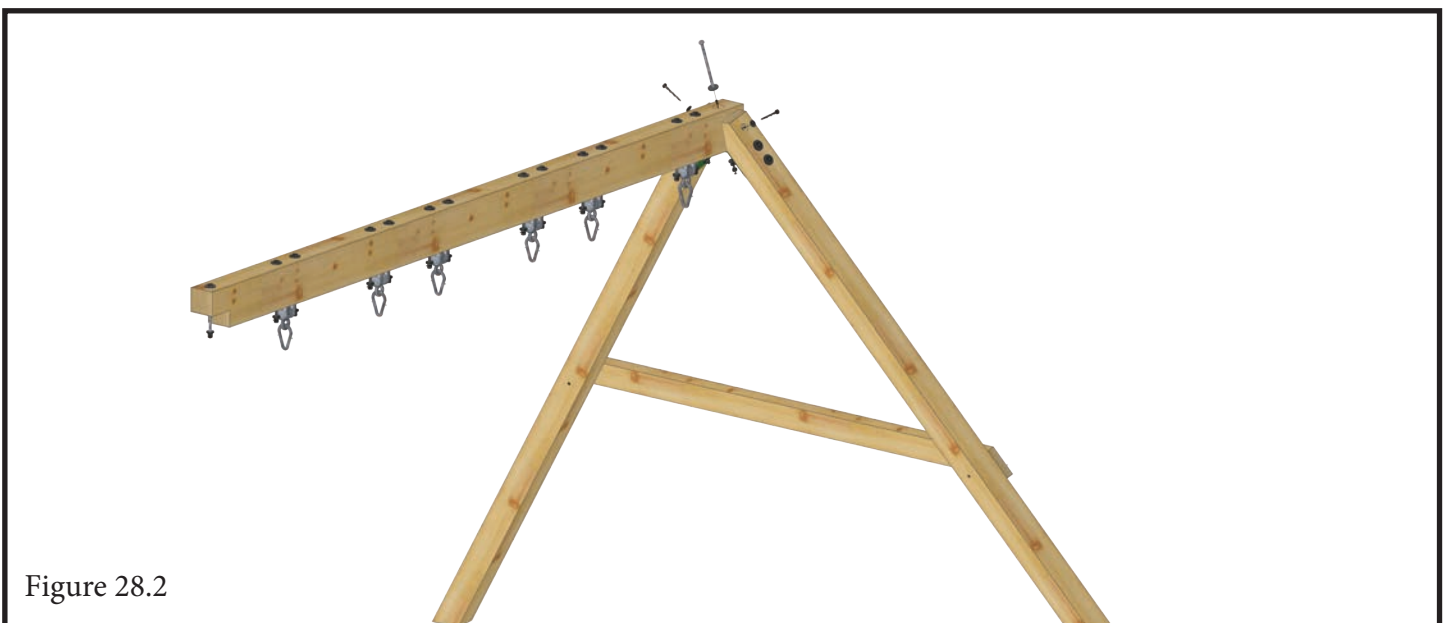

Figure 28.2

Step Twenty-Nine: Slide & Swings

29.1 Fasten Swing Beam Assembly to Swing Beam Support with 3/8" x 7" Carriage Bolt with 1/2 Washer. Add 3/8" Washer, Lock Washer, and Nut. Tighten.

29.2 Fasten the slide to the play set deck with (3) 2" Pan Head Screws.

29.3 Fasten the swings to the spring clips at desired height on the chain.

